

Obvodový oceľový profil Frame steel profile										
Kód/Code	Povrch. úprava Surface treat.	S	Dĺžka v mm Length in mm	A	B	C	D	E	F	Váha/Weight
142922	surový/raw	2,0	6000,6500	92	60	28	17	22	71	3,340 kg/m
141722	surový/raw	3,0	6500	109	65	30	21	30	82	5,930 kg/m

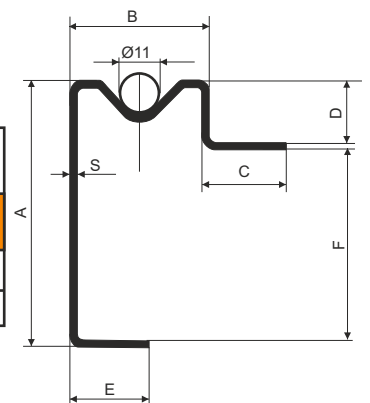

Obvodový oceľový profil Frame steel profile										
Kód/Code	Povrch. úprava Surface treat.	S	Dĺžka v mm Length in mm	A	B	C	D	E	F	Váha/Weight
142765	surový/raw	2,0	6000	81	40	27	15	28	62	2,780 kg/m
142766	surový/raw	2,0	6500	84	50	27	18	22	62	2,920 kg/m
142768	surový/raw	2,5	6500	108	50	30	21	25	82	4,030 kg/m
142769	surový/raw	3,0	6500	111	50	30	24	27	81	5,010 kg/m
142770	surový/raw	3,0	6500	116	50	33	27	35	83	5,380 kg/m

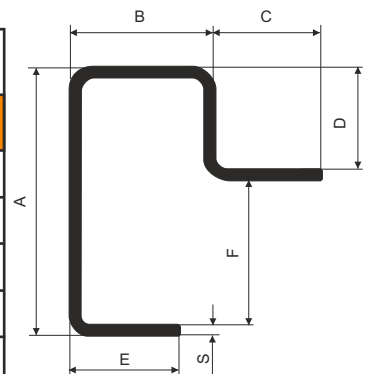

Obvodový oceľový profil 160/3/27 mm Frame steel profile 160/3/27 mm										
Kód/Code	Povrch. úprava Surface treat.	S	Dĺžka v mm Length in mm	A	B	C	D	F	Váha/Weight	
141626	surový/raw	3,0	6500	160	50	40	27	45	6,800 kg/m	
141628	surový/raw	3,0	7000	160	50	40	27	45	6,800 kg/m	
141629	surový/raw	3,0	8000	160	50	40	27	45	6,800 kg/m	

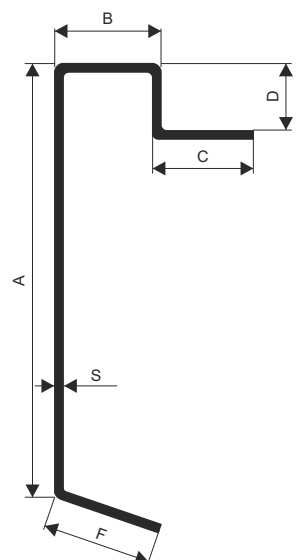

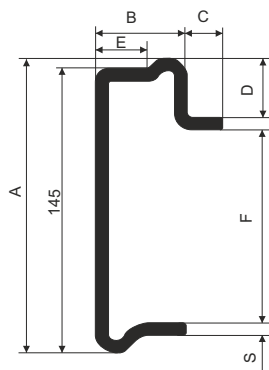

Obvodový oceľový profil  
Frame steel profile

Kód/Code	Povrch. úprava Surface treat.	S	Dĺžka v mm Length in mm	A	B	C	D	E	F	Váha/Weight
142678	surový/raw	3,5	6150	155	50	24	31	27	102	7,910 kg/m
142679	surový/raw	3,5	8300	155	50	24	31	27	102	7,910 kg/m

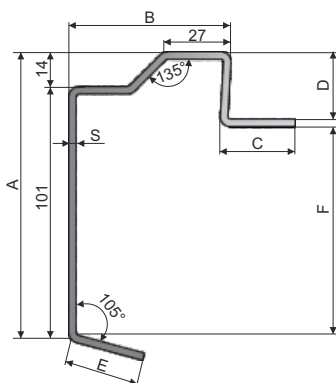

Obvodový oceľový profil  
Frame steel profile

Kód/Code	Povrch. úprava Surface treat.	S	Dĺžka v mm Length in mm	A	B	C	D	E	F	Váha/Weight
141727	surový/raw	3,0	6150, 7500	115	65	30	27	30	82	6,020 kg/m

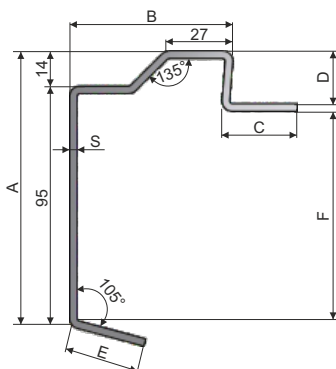

Obvodový oceľový profil  
Frame steel profile

Kód/Code	Povrch. úprava Surface treat.	S	Dĺžka v mm Length in mm	A	B	C	D	E	F	Váha/Weight
141721	surový/raw	3,0	6500, 7500	109	65	30	21	30	82	5,820 kg/m

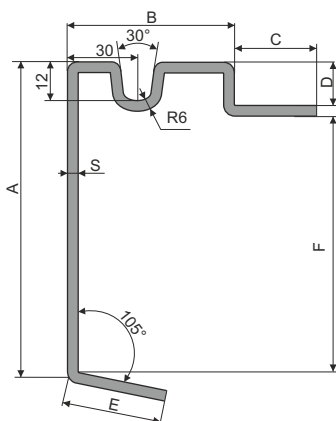

Obvodový oceľový profil  
Frame steel profile

Kód/Code	Povrch. úprava Surface treat.	S	Dĺžka v mm Length in mm	A	B	C	D	E	F	Váha/Weight
142715	surový/raw	2,0	6500	100	60	30	15	30	80	3,800 kg/m