

Hliníková bočnica 300 mm Aluminium sideboard profile 300 mm				
Kód/Code	Materiál/Mat.	Povrch.úprava Surface treat.	MJ/UM	Váha/Weight
116830	hliník/alumin.	elox./eloxed	meter	3,213 kg/m

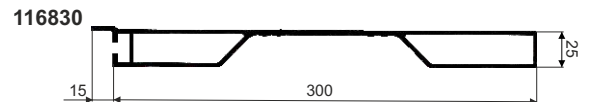

Hliníková bočnica 350 mm Aluminium sideboard profile 350 mm				
Kód/Code	Materiál/Mat.	Povrch.úprava Surface treat.	MJ/UM	Váha/Weight
117784	hliník/alumin.	elox./eloxed	meter	3,308 kg/m
112222	hliník/alumin.	elox./eloxed	meter	3,640 kg/m

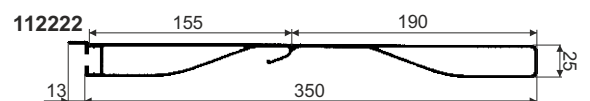
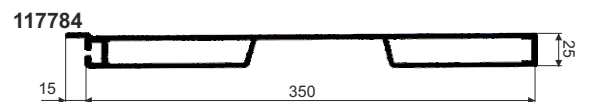

Hliníková bočnica 400 mm Aluminium sideboard profile 400 mm				
Kód/Code	Materiál/Mat.	Povrch.úprava Surface treat.	MJ/UM	Váha/Weight
114505	hliník/alumin.	elox./eloxed	meter	4,700 kg/m
115305	hliník/alumin.	elox./eloxed	meter	4,109 kg/m
116018	hliník/alumin.	elox./eloxed	meter	4,285 kg/m
113367	hliník/alumin.	elox./eloxed	meter	4,209 kg/m
116014	hliník/alumin.	elox./eloxed	meter	3,890 kg/m
116016	hliník/alumin.	elox./eloxed	meter	3,940 kg/m

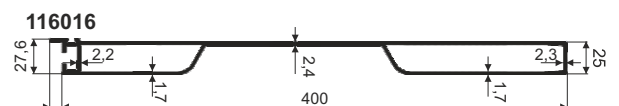
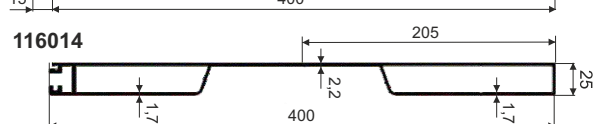
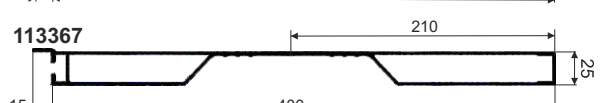
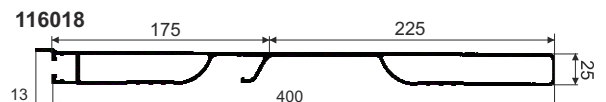
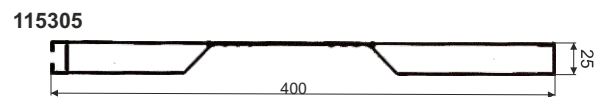
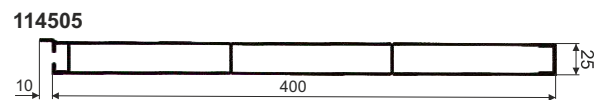

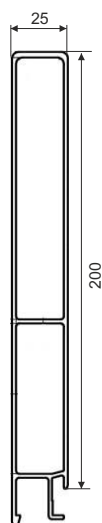

118196

**Horný bočnicový profil EUROLOCK - 200 mm**  
**Top profile EUROLOCK - 200 mm**

Kód/Code	Materiál/Mat.	Povrch.úprava Surface treat.	MJ/UM	Váha/Weight
118196	hliník/alumin.	elox./eloxed	meter	2,523 kg/m

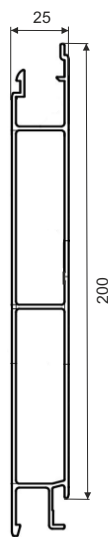

117046

**Stredný bočnicový plný profil EUROLOCK - 200 mm**  
**Central sideboard full profile EUROLOCK - 200 mm**

Kód/Code	Materiál/Mat.	Povrch.úprava Surface treat.	MJ/UM	Váha/Weight
117046	hliník/alumin.	elox./eloxed	meter	2,539 kg/m

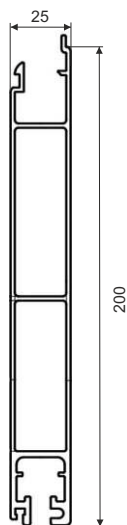

117785

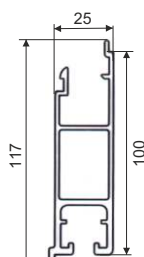

118197

**Spodný bočnicový profil EUROLOCK - 200 mm**  
**Bottom sideboard profile EUROLOCK - 200 mm**

Kód/Code	Materiál/Mat.	Povrch.úprava Surface treat.	MJ/UM	Váha/Weight
117785	hliník/alumin.	elox./eloxed	meter	2,675 kg/m

**Spodný bočnicový profil s jazýčkom EUROLOCK - 100 mm**  
**Bottom sideboard profile with edge EUROLOCK - 100 mm**

Kód/Code	Materiál/Mat.	Povrch.úprava Surface treat.	MJ/UM	Váha/Weight
118197	hliník/alumin.	elox./eloxed	meter	1,593 kg/m

Stredný bočnicový plachtový profil 200 mm Central sideboard tarpaulin profile 200 mm				
Kód/Code	Materiál/Mat.	Povrch.úprava Surface treat.	MJ/UM	Váha/Weight
113477	hliník/alumin.	elox./eloxed	meter	2,020 kg/m

Stredný bočnicový plachtový profil 100 mm Central sideboard tarpaulin profile 100 mm				
Kód/Code	Materiál/Mat.	Povrch.úprava Surface treat.	MJ/UM	Váha/Weight
113634	hliník/alumin.	elox./eloxed	meter	1,023 kg/m

Stredný bočnicový plný profil 200 mm Central sideboard full profile 200 mm				
Kód/Code	Materiál/Mat.	Povrch.úprava Surface treat.	MJ/UM	Váha/Weight
113385	hliník/alumin.	elox./eloxed	meter	2,152 kg/m

Stredný bočnicový plný profil 100 mm Central sideboard full profile 100 mm				
Kód/Code	Materiál/Mat.	Povrch.úprava Surface treat.	MJ/UM	Váha/Weight
113635	hliník/alumin.	elox./eloxed	meter	1,244 kg/m

Spodný bočnicový profil s jazýčkom 200 mm Bottom sideboard profile with edge 200 mm				
Kód/Code	Materiál/Mat.	Povrch.úprava Surface treat.	MJ/UM	Váha/Weight
113474	hliník/alumin.	elox./eloxed	meter	2,538 kg/m

Spodný bočnicový profil 220 mm Bottom sideboard profile 220 mm				
Kód/Code	Materiál/Mat.	Povrch.úprava Surface treat.	MJ/UM	Váha/Weight
113475	hliník/alumin.	elox./eloxed	meter	2,581 kg/m

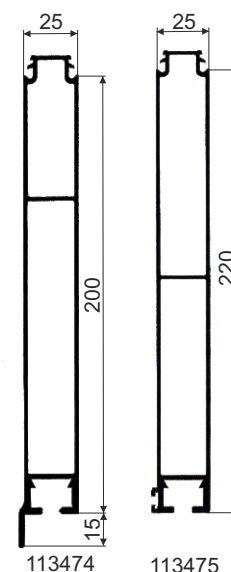
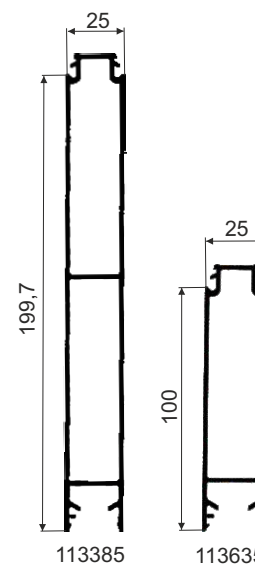
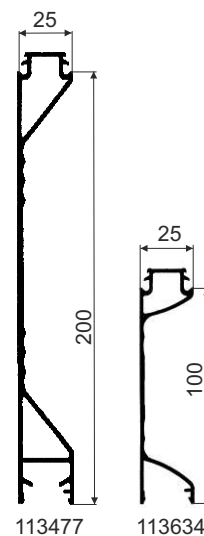

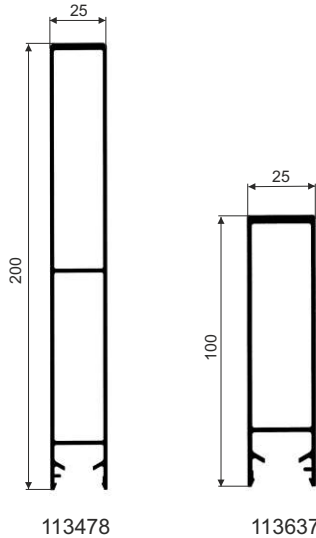

113478

113637

Horný bočnicový profil 200 mm Top profile 200 mm				
Kód/Code	Materiál/Mat.	Povrch.úprava Surface treat.	MJ/UM	Váha/Weight
113478	hliník/alumin.	elox./eloxed	meter	2,157 kg/m

Horný bočnicový profil 100 mm Top profile 100 mm				
Kód/Code	Materiál/Mat.	Povrch.úprava Surface treat.	MJ/UM	Váha/Weight
113637	hliník/alumin.	elox./eloxed	meter	1,201 kg/m

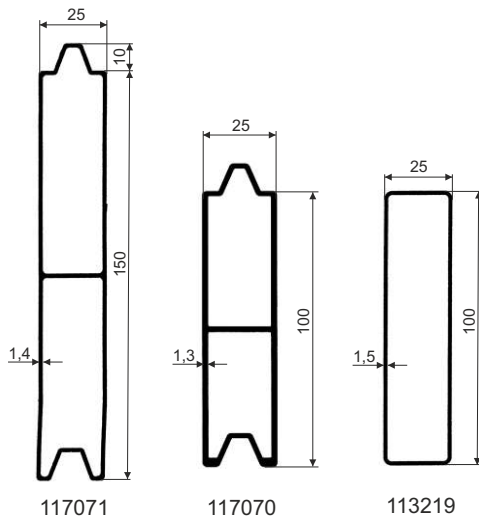

117071

117070

113219

Šípový profil 150 mm Side profile 150 mm				
Kód/Code	Materiál/Mat.	Povrch.úprava Surface treat.	MJ/UM	Váha/Weight
117071	hliník/alumin.	surový/raw	meter	1,860 kg/m

Šípový profil 100 mm Side profile 100 mm				
Kód/Code	Materiál/Mat.	Povrch.úprava Surface treat.	MJ/UM	Váha/Weight
117070	hliník/alumin.	surový/raw	meter	1,310 kg/m

Hliníkový profil podplachtový 100x25 mm Tarpaulin profile 100x25 mm				
Kód/Code	Materiál/Mat.	Povrch.úprava Surface treat.	MJ/UM	Váha/Weight
113219	hliník/alumin.	surový/raw	meter	0,985 kg/m



Záslepka do podplachtového profilu Edging plug for tarpaulin profile				
Kód/Code	Farba/Color	Rozmery Dimensions	MJ/UM	Váha/Weight
461025	čierna/black	100x25	kus/piece	0,015 kg

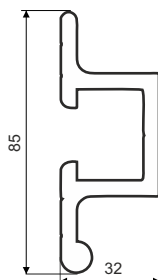
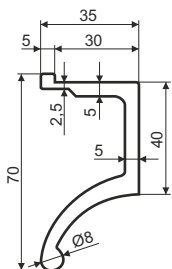

Profil rámu CS 70x35 mm Frame profile CS 70x35 mm				
Kód/Code	Materiál/Mat.	Povrch.úprava Surface treat.	MJ/UM	Váha/Weight
119040	hliník/alumin.	surový/raw	meter	1,530 kg/m

Profil rámu OMEGA 85x32 mm Frame profile OMEGA 85x32 mm				
Kód/Code	Materiál/Mat.	Povrch.úprava Surface treat.	MJ/UM	Váha/Weight
119041	hliník/alumin.	surový/raw	meter	2,120 kg/m

**Hliníkové bočnicové profily**  
**Aluminium sideboard profiles**

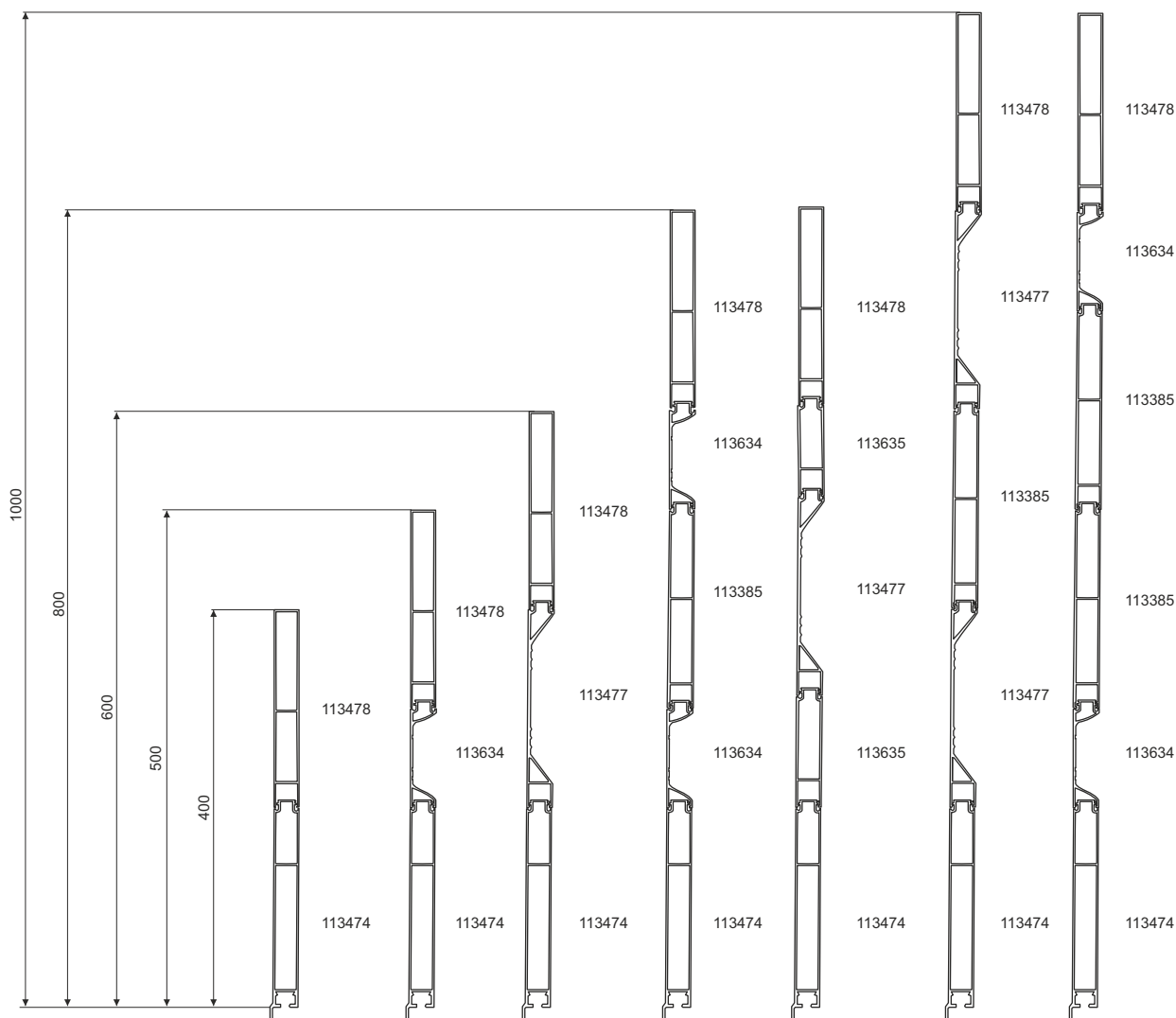

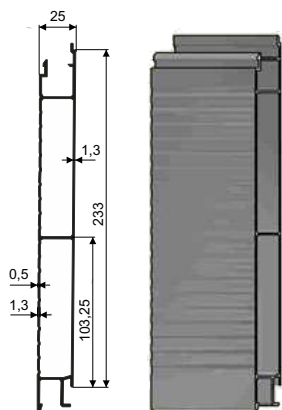

Stredný bočnicový profil WAVE 233 mm Central sideboard profile WAVE 233 mm				
Kód/Code	Materiál/Mat.	Povrch.úprava Surface treat.	MJ/UM	Váha/Weight
113390	hliník/alumin.	elox./eloxed	meter	2,236 kg/m
113391	hliník/alumin.	surový/raw	meter	2,236 kg/m

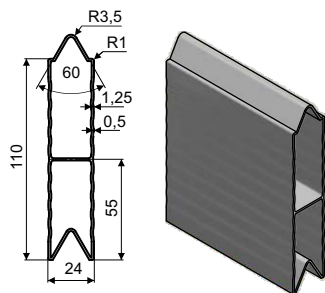

Šípový profil WAVE - 110 mm Side profile WAVE - 110 mm				
Kód/Code	Materiál/Mat.	Povrch.úprava Surface treat.	MJ/UM	Váha/Weight
117072	hliník/alumin.	surový/raw	meter	1,080 kg/m
117073	hliník/alumin.	elox./eloxed	meter	1,080 kg/m

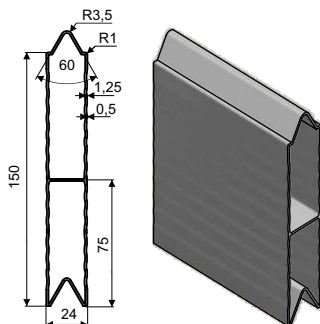

Šípový profil WAVE - 150 mm Side profile WAVE - 150 mm				
Kód/Code	Materiál/Mat.	Povrch.úprava Surface treat.	MJ/UM	Váha/Weight
117077	hliník/alumin.	surový/raw	meter	1,400 kg/m
117078	hliník/alumin.	elox./eloxed	meter	1,400 kg/m

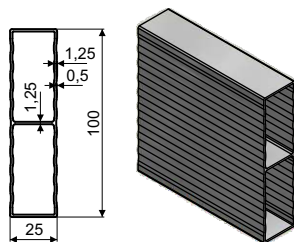

Hliníkový profil podplachtový WAVE - 100x25 mm Tarpaulin profile WAVE - 100x25 mm				
Kód/Code	Materiál/Mat.	Povrch.úprava Surface treat.	MJ/UM	Váha/Weight
113220	hliník/alumin.	elox./eloxed	meter	0,905 kg/m
113221	hliník/alumin.	surový/raw	meter	0,905 kg/m



Lemovací profil "U" 25 mm Edging profile "U" 25 mm				
Kód/Code	Materiál/Mat.	Povrch.úprava Surface treat.	MJ/UM	Váha/Weight
110326	hliník/alumin.	elox./eloxed	meter	0,729 kg/m



Lemovací profil "H" 25 mm Edging profile "H" 25 mm				
Kód/Code	Materiál/Mat.	Povrch.úprava Surface treat.	MJ/UM	Váha/Weight
110327	hliník/alumin.	elox./eloxed	meter	1,010 kg/m

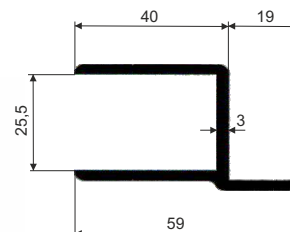

Lemovací profil "H" 25 mm Edging profile "H" 25 mm				
Kód/Code	Materiál/Mat.	Povrch.úprava Surface treat.	MJ/UM	Váha/Weight
112060	hliník/alumin.	elox./eloxed	meter	0,970 kg/m

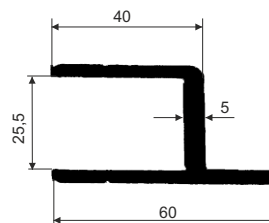

Bočný lemovací profil pre MAX Side edging profile MAX				
Kód/Code	Materiál/Mat.	Povrch.úprava Surface treat.	MJ/UM	Váha/Weight
111620	hliník/alumin.	elox./eloxed	meter	0,805 kg/m

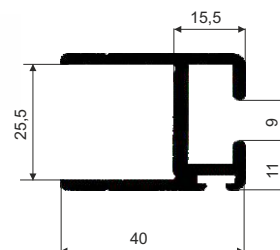

Bočný lemovací profil pre MAX Side edging profile MAX				
Kód/Code	Materiál/Mat.	Povrch.úprava Surface treat.	MJ/UM	Váha/Weight
111621	hliník/alumin.	elox./eloxed	meter	0,996 kg/m

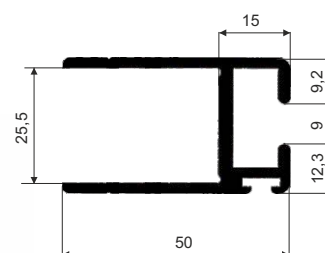

Zadný lemovací profil pre MAX Rear edging profile MAX				
Kód/Code	Materiál/Mat.	Povrch.úprava Surface treat.	MJ/UM	Váha/Weight
111094	hliník/alumin.	elox./eloxed	meter	1,220 kg/m

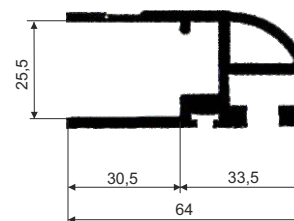

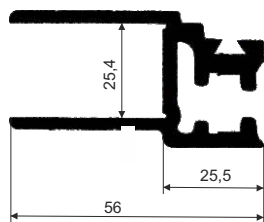

**Bočný lemovací profil K20 pre Kinnegrip**  
**Side edging profile K20 for Kinnegrip**

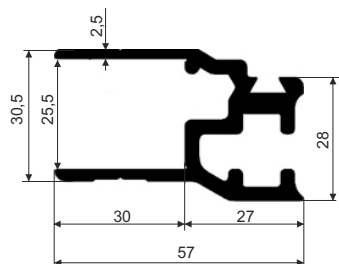
Kód/Code	Materiál/Mat.	Povrch.úprava Surface treat.	MJ/UM	Váha/Weight
110899	hliník/alumin.	elox./eloxed	meter	1,290 kg/m

**Bočný lemovací profil K20 pre Kinnegrip 27 mm**  
**Side edging profile K20 for Kinnegrip 27 mm**

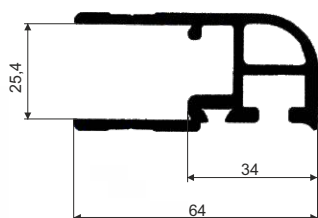
Kód/Code	Materiál/Mat.	Povrch.úprava Surface treat.	MJ/UM	Váha/Weight
110827	hliník/alumin.	elox./eloxed	meter	1,170 kg/m

**Zadný lemovací profil K20 pre Kinnegrip**  
**Rear edging profile K20 for Kinnegrip**

Kód/Code	Materiál/Mat.	Povrch.úprava Surface treat.	MJ/UM	Váha/Weight
110900	hliník/alumin.	elox./eloxed	meter	1,220 kg/m

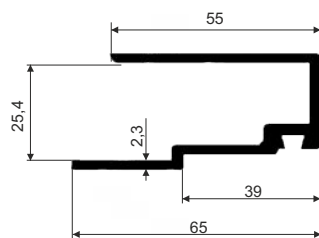
**Bočný lemovací profil pre uzáver H681**  
**Side edging profile for lock H681**

Kód/Code	Materiál/Mat.	Povrch.úprava Surface treat.	MJ/UM	Váha/Weight
110328	hliník/alumin.	elox./eloxed	meter	0,980 kg/m



## OBJEDNÁVKOVÝ FORMULÁR PRE ELOXOVANÉ BOČNICE

Názov firmy:

Objednávateľ:

Dopyt číslo:



Telefón:

Objednávka číslo:



Fax:

Dátum:

Dodací termín:

Celková dĺžka (mm)

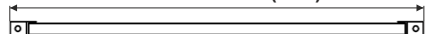









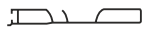
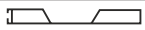
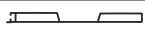

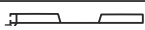
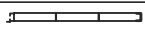
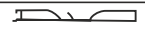
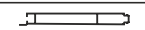















Skladať:

 Bočnice

 ZČ

 PČ

BOČNICA				bočnica 1	bočnica 2	bočnica 3	zadné čelo	predné čelo
POČET KUSOV								
DĹŽKA CELKOVÁ (mm)								
VÝŠKA BOČNICE (mm)								
POČET PÁNTOV								
názov	obrázok	rozmer	kód					
plachtový s nosom		400	116018	<input type="checkbox"/>	<input type="checkbox"/>	<input type="checkbox"/>	<input type="checkbox"/>	<input type="checkbox"/>
plachtový		400	115305	<input type="checkbox"/>	<input type="checkbox"/>	<input type="checkbox"/>	<input type="checkbox"/>	<input type="checkbox"/>
plachtový s jazýčkom		400	113367	<input type="checkbox"/>	<input type="checkbox"/>	<input type="checkbox"/>	<input type="checkbox"/>	<input type="checkbox"/>
plachtový s tesnením		400	116014	<input type="checkbox"/>	<input type="checkbox"/>	<input type="checkbox"/>	<input type="checkbox"/>	<input type="checkbox"/>
plachtový s tesnením		400	116016	<input type="checkbox"/>	<input type="checkbox"/>	<input type="checkbox"/>	<input type="checkbox"/>	<input type="checkbox"/>
plný bočnicový profil		400	114505	<input type="checkbox"/>	<input type="checkbox"/>	<input type="checkbox"/>	<input type="checkbox"/>	<input type="checkbox"/>
plachtový s nosom		350	112222	<input type="checkbox"/>	<input type="checkbox"/>	<input type="checkbox"/>	<input type="checkbox"/>	<input type="checkbox"/>
spodný s jazýčkom		200	113474	<input type="checkbox"/>	<input type="checkbox"/>	<input type="checkbox"/>	<input type="checkbox"/>	<input type="checkbox"/>
spodný bez jazýčka		220	113475	<input type="checkbox"/>	<input type="checkbox"/>	<input type="checkbox"/>	<input type="checkbox"/>	<input type="checkbox"/>
stredný plný		200	113385	<input type="checkbox"/>	<input type="checkbox"/>	<input type="checkbox"/>	<input type="checkbox"/>	<input type="checkbox"/>
stredný plný		100	113635	<input type="checkbox"/>	<input type="checkbox"/>	<input type="checkbox"/>	<input type="checkbox"/>	<input type="checkbox"/>
stredný plachtový		200	113477	<input type="checkbox"/>	<input type="checkbox"/>	<input type="checkbox"/>	<input type="checkbox"/>	<input type="checkbox"/>
stredný plachtový		100	113634	<input type="checkbox"/>	<input type="checkbox"/>	<input type="checkbox"/>	<input type="checkbox"/>	<input type="checkbox"/>
horný		200	113478	<input type="checkbox"/>	<input type="checkbox"/>	<input type="checkbox"/>	<input type="checkbox"/>	<input type="checkbox"/>
horný		100	113637	<input type="checkbox"/>	<input type="checkbox"/>	<input type="checkbox"/>	<input type="checkbox"/>	<input type="checkbox"/>

lemovanie	obrázok	rozmer	kód	ľavý	pravý	ľavý	pravý	ľavý	pravý	ľavý	pravý	ľavý	pravý
"U" profil		3	110326	<input type="checkbox"/>	<input type="checkbox"/>	<input type="checkbox"/>	<input type="checkbox"/>	<input type="checkbox"/>	<input type="checkbox"/>	<input type="checkbox"/>	<input type="checkbox"/>	<input type="checkbox"/>	<input type="checkbox"/>
"H" profil		3	110327	<input type="checkbox"/>	<input type="checkbox"/>	<input type="checkbox"/>	<input type="checkbox"/>	<input type="checkbox"/>	<input type="checkbox"/>	<input type="checkbox"/>	<input type="checkbox"/>	<input type="checkbox"/>	<input type="checkbox"/>
"H" profil		4,8	112060	<input type="checkbox"/>	<input type="checkbox"/>	<input type="checkbox"/>	<input type="checkbox"/>	<input type="checkbox"/>	<input type="checkbox"/>	<input type="checkbox"/>	<input type="checkbox"/>	<input type="checkbox"/>	<input type="checkbox"/>
Kinnegrip bočný		27	110827	<input type="checkbox"/>	<input type="checkbox"/>	<input type="checkbox"/>	<input type="checkbox"/>	<input type="checkbox"/>	<input type="checkbox"/>	<input type="checkbox"/>	<input type="checkbox"/>	<input type="checkbox"/>	<input type="checkbox"/>
Kinnegrip zadný		34	110900	<input type="checkbox"/>	<input type="checkbox"/>	<input type="checkbox"/>	<input type="checkbox"/>	<input type="checkbox"/>	<input type="checkbox"/>	<input type="checkbox"/>	<input type="checkbox"/>	<input type="checkbox"/>	<input type="checkbox"/>
Max bočný		15	111620	<input type="checkbox"/>	<input type="checkbox"/>	<input type="checkbox"/>	<input type="checkbox"/>	<input type="checkbox"/>	<input type="checkbox"/>	<input type="checkbox"/>	<input type="checkbox"/>	<input type="checkbox"/>	<input type="checkbox"/>
Max zadný		33	111094	<input type="checkbox"/>	<input type="checkbox"/>	<input type="checkbox"/>	<input type="checkbox"/>	<input type="checkbox"/>	<input type="checkbox"/>	<input type="checkbox"/>	<input type="checkbox"/>	<input type="checkbox"/>	<input type="checkbox"/>
Planae Export bez lemu		46		<input type="checkbox"/>	<input type="checkbox"/>	<input type="checkbox"/>	<input type="checkbox"/>	<input type="checkbox"/>	<input type="checkbox"/>	<input type="checkbox"/>	<input type="checkbox"/>	<input type="checkbox"/>	<input type="checkbox"/>
Planae Export s lemom		46		<input type="checkbox"/>	<input type="checkbox"/>	<input type="checkbox"/>	<input type="checkbox"/>	<input type="checkbox"/>	<input type="checkbox"/>	<input type="checkbox"/>	<input type="checkbox"/>	<input type="checkbox"/>	<input type="checkbox"/>
Planae 2 s lemom		46		<input type="checkbox"/>	<input type="checkbox"/>	<input type="checkbox"/>	<input type="checkbox"/>	<input type="checkbox"/>	<input type="checkbox"/>	<input type="checkbox"/>	<input type="checkbox"/>	<input type="checkbox"/>	<input type="checkbox"/>
Planae 5 bez lemu		44,4		<input type="checkbox"/>	<input type="checkbox"/>	<input type="checkbox"/>	<input type="checkbox"/>	<input type="checkbox"/>	<input type="checkbox"/>	<input type="checkbox"/>	<input type="checkbox"/>	<input type="checkbox"/>	<input type="checkbox"/>
Planae 6				<input type="checkbox"/>	<input type="checkbox"/>	<input type="checkbox"/>	<input type="checkbox"/>	<input type="checkbox"/>	<input type="checkbox"/>	<input type="checkbox"/>	<input type="checkbox"/>	<input type="checkbox"/>	<input type="checkbox"/>
Bez lemovania				<input type="checkbox"/>	<input type="checkbox"/>	<input type="checkbox"/>	<input type="checkbox"/>	<input type="checkbox"/>	<input type="checkbox"/>	<input type="checkbox"/>	<input type="checkbox"/>	<input type="checkbox"/>	<input type="checkbox"/>
Tir-pánt záves pozink.			052811										
Tir-pánt čap pozink.			052801										
Doštička 50 mm			052791										
Doštička 70 mm			052781										
Skrutka M8x20			053421										

**POZNÁMKY / POŽIADAVKY:**

**OBJEDNÁVKOVÝ FORMULÁR PRE ELOXOVANÉ BOČNICE EUROLOCK**

 Názov firmy:   
 Dopyt číslo:   
 Objednávka číslo:   
 Dátum: 

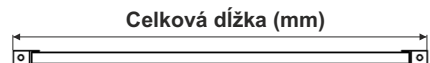
 Objednávateľ:   
 Telefón:   
 Fax:   
 Dodací termín: 

 Skladať:  Bočnice  ZČ  PČ

BOČNICA	bočnica 1	bočnica 2	bočnica 3	zadné čelo	predné čelo
POČET KUSOV					
DĹŽKA CELKOVÁ (mm)					
VÝŠKA BOČNICE (mm)					
POČET PÁNTOV					
názov	obrázok	rozmer	kód		
spodný s jazýčkom		100	118197	<input type="checkbox"/>	<input type="checkbox"/>
spodný bez jazýčka		200	117785	<input type="checkbox"/>	<input type="checkbox"/>
stredný plný		200	117046	<input type="checkbox"/>	<input type="checkbox"/>
horný		200	118196	<input type="checkbox"/>	<input type="checkbox"/>

lemovanie	rozmer	kód	ľavý	pravý	ľavý	pravý	ľavý	pravý	ľavý	pravý	ľavý	pravý	ľavý	pravý
"U" profil		3	110326	<input type="checkbox"/>	<input type="checkbox"/>	<input type="checkbox"/>	<input type="checkbox"/>	<input type="checkbox"/>	<input type="checkbox"/>	<input type="checkbox"/>	<input type="checkbox"/>	<input type="checkbox"/>	<input type="checkbox"/>	<input type="checkbox"/>
"H" profil		3	110327	<input type="checkbox"/>	<input type="checkbox"/>	<input type="checkbox"/>	<input type="checkbox"/>	<input type="checkbox"/>	<input type="checkbox"/>	<input type="checkbox"/>	<input type="checkbox"/>	<input type="checkbox"/>	<input type="checkbox"/>	<input type="checkbox"/>
"H" profil		4,8	112060	<input type="checkbox"/>	<input type="checkbox"/>	<input type="checkbox"/>	<input type="checkbox"/>	<input type="checkbox"/>	<input type="checkbox"/>	<input type="checkbox"/>	<input type="checkbox"/>	<input type="checkbox"/>	<input type="checkbox"/>	<input type="checkbox"/>
Kinnegrip bočný		27	110827	<input type="checkbox"/>	<input type="checkbox"/>	<input type="checkbox"/>	<input type="checkbox"/>	<input type="checkbox"/>	<input type="checkbox"/>	<input type="checkbox"/>	<input type="checkbox"/>	<input type="checkbox"/>	<input type="checkbox"/>	<input type="checkbox"/>
Kinnegrip zadný		34	110900	<input type="checkbox"/>	<input type="checkbox"/>	<input type="checkbox"/>	<input type="checkbox"/>	<input type="checkbox"/>	<input type="checkbox"/>	<input type="checkbox"/>	<input type="checkbox"/>	<input type="checkbox"/>	<input type="checkbox"/>	<input type="checkbox"/>
Max bočný		15	111620	<input type="checkbox"/>	<input type="checkbox"/>	<input type="checkbox"/>	<input type="checkbox"/>	<input type="checkbox"/>	<input type="checkbox"/>	<input type="checkbox"/>	<input type="checkbox"/>	<input type="checkbox"/>	<input type="checkbox"/>	<input type="checkbox"/>
Max zadný		33	111094	<input type="checkbox"/>	<input type="checkbox"/>	<input type="checkbox"/>	<input type="checkbox"/>	<input type="checkbox"/>	<input type="checkbox"/>	<input type="checkbox"/>	<input type="checkbox"/>	<input type="checkbox"/>	<input type="checkbox"/>	<input type="checkbox"/>
Planae Export bez lemu		46		<input type="checkbox"/>	<input type="checkbox"/>	<input type="checkbox"/>	<input type="checkbox"/>	<input type="checkbox"/>	<input type="checkbox"/>	<input type="checkbox"/>	<input type="checkbox"/>	<input type="checkbox"/>	<input type="checkbox"/>	<input type="checkbox"/>
Planae Export s lemom		46		<input type="checkbox"/>	<input type="checkbox"/>	<input type="checkbox"/>	<input type="checkbox"/>	<input type="checkbox"/>	<input type="checkbox"/>	<input type="checkbox"/>	<input type="checkbox"/>	<input type="checkbox"/>	<input type="checkbox"/>	<input type="checkbox"/>
Planae 2 s lemom		46		<input type="checkbox"/>	<input type="checkbox"/>	<input type="checkbox"/>	<input type="checkbox"/>	<input type="checkbox"/>	<input type="checkbox"/>	<input type="checkbox"/>	<input type="checkbox"/>	<input type="checkbox"/>	<input type="checkbox"/>	<input type="checkbox"/>
Planae 5 bez lemu		44,4		<input type="checkbox"/>	<input type="checkbox"/>	<input type="checkbox"/>	<input type="checkbox"/>	<input type="checkbox"/>	<input type="checkbox"/>	<input type="checkbox"/>	<input type="checkbox"/>	<input type="checkbox"/>	<input type="checkbox"/>	<input type="checkbox"/>
Planae 6				<input type="checkbox"/>	<input type="checkbox"/>	<input type="checkbox"/>	<input type="checkbox"/>	<input type="checkbox"/>	<input type="checkbox"/>	<input type="checkbox"/>	<input type="checkbox"/>	<input type="checkbox"/>	<input type="checkbox"/>	<input type="checkbox"/>
Bez lemovania				<input type="checkbox"/>	<input type="checkbox"/>	<input type="checkbox"/>	<input type="checkbox"/>	<input type="checkbox"/>	<input type="checkbox"/>	<input type="checkbox"/>	<input type="checkbox"/>	<input type="checkbox"/>	<input type="checkbox"/>	<input type="checkbox"/>
Tir-pánt záves pozink.			052811											
Tir-pánt čap pozink.			052801											
Doštička 50 mm			052791											
Doštička 70 mm			052781											
Skrutka M8x20			053421											

**POZNÁMKY / POŽIADAVKY:**

---

---

---

---

---

---

---

---

---

---

---

---

---

---

---

---

---

---

---

---

---

---

---

---