

Kockon 105 univerzálny Kockon 105 universal			
Kód/Code	Materiál Material	MJ/UM	Váha Weight
300105	kov a plast steel and plastic	kus/piece	1,670 kg

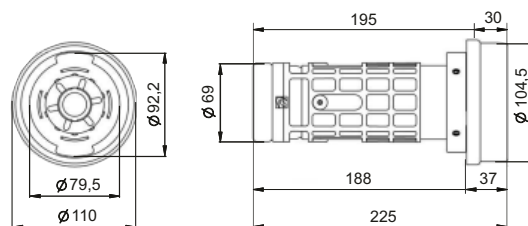

Kockon M2 105 XL, PL-CAP, typ bajonet s uzáverom Kockon M2 105 XL, PL-CAP, typ bayonet with cap			
Kód/Code	Materiál Material	MJ/UM	Váha Weight
300138	hliník a plast aluminium and plastic	kus/piece	1,150 kg

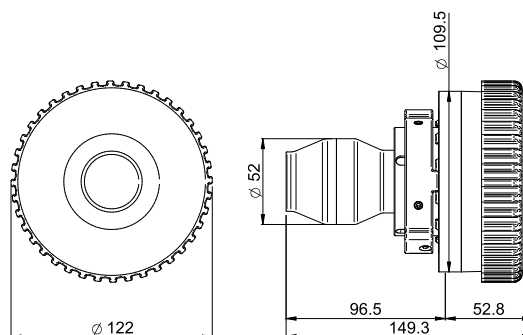

Kockon M2 80 XL, PL-CAP, typ Scania s uzáverom Kockon M2 80 XL, PL-CAP, typ Scania with cap			
Kód/Code	Materiál Material	MJ/UM	Váha Weight
300139	hliník a plast aluminium and plastic	kus/piece	0,922 kg

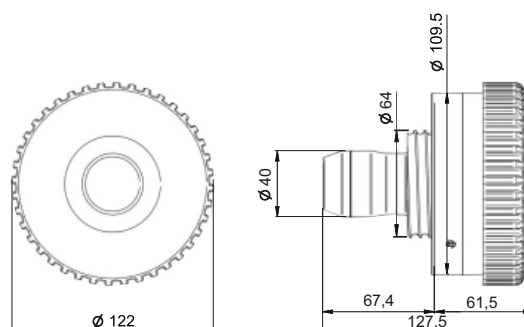

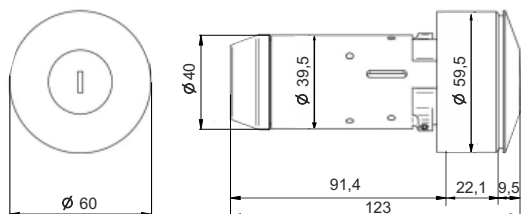

Kockon M2 VX, Mercedes Sprinter/VW Crafter od roku 2010 s uzáverom
Kockon M2 VX, Mercedes Sprinter/VW Crafter since 2010 with cap

Kód/Code	Materiál Material	MJ/UM	Váha Weight
300140	hliník a plast aluminium and plastic	kus/piece	0,342 kg

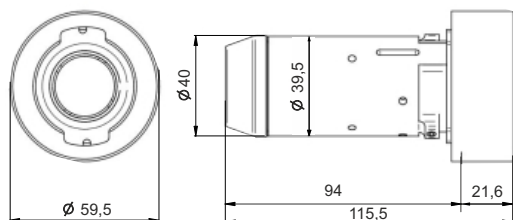

Kockon M2 VX, Iveco Daily od roku 2010 bez uzáveru
Kockon M2 VX, Iveco Daily since 2010 without cap

Kód/Code	Materiál Material	MJ/UM	Váha Weight
300141	hliník a plast aluminium and plastic	kus/piece	0,246 kg

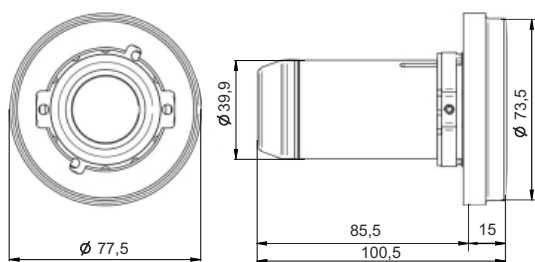

Kockon M2 VX, Nissan Cabstar/Renault Maxity od roku 2010 bez uzáveru
Kockon M2 VX, Nissan Cabstar/Renault Maxity since 2010 without cap

Kód/Code	Materiál Material	MJ/UM	Váha Weight
300142	hliník a plast aluminium and plastic	kus/piece	0,276 kg

Formulár na overenie kompatibility výrobku

DÁTUM: ____ / ____ / ____ NÁZOV FIRMY: _____

ŠTÁT: _____ MENO A TEL. KONTAKT: _____

ÚDAJE VOZIDLA

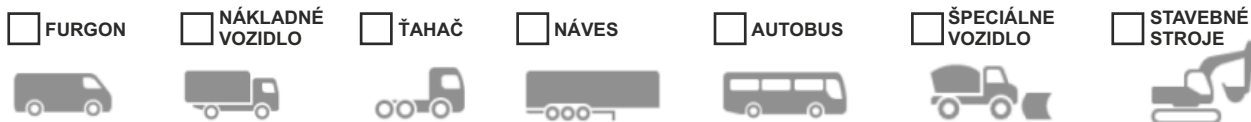

VÝROBCA: _____ MODEL: _____

ROK VÝROBY: _____ VO VÝROBE: ÁNO NIE

TYP OBJÍMKY

2 BODOVÁ - BAJONET S VNÚTORNÝM ZÁVITOM S VONKAJŠÍM ZÁVITOM 3 BODOVÁ - BAJONET BEZ OBJÍMKY

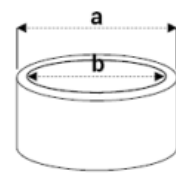
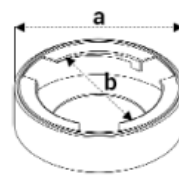
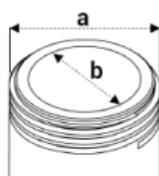
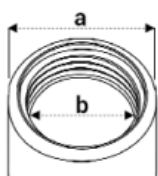
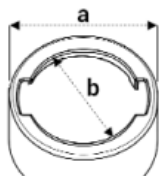

OSTATNÉ ÚDAJE

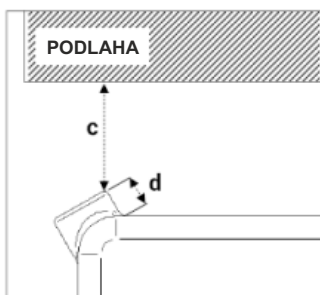

ROZMERY NÁDRŽE

c: _____ mm

d: _____ mm

MATERIÁL NÁDRŽE

- OCEL
 PLAST
 PLAST s OCELOVOU OBJÍMKOU

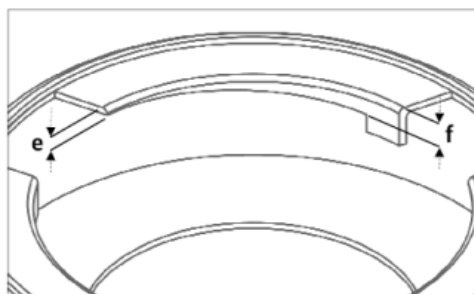

VODIACE ROZMERY OBJÍMKY

e: _____ mm

f: _____ mm

FOTOGRAFIE

Žiadame vyhotoviť 4 fotografie (ako je to zobrazené na obrázkoch)

- 1 - čelný pohľad
- 2 - ľavá strana
- 3 - pravá strana
- 4 - objímka nádrže

V prípade špeciálnych požiadaviek pripojiť ďalšie fotografie.



POZNÁMKY
