

#### Homologované zábrany - hliníkové

Zábranový profil hliníkový, eloxovaný - H 150mm  
Aluminium bar for side protection, eloxed - H 150mm

Kód/Code	Materiál/Mat.	MJ/UM	Váha Weight
141540	hliník/aluminium	kus/piece	1,564 kg

 VCA Homologácia  
VCA approved  
E11 73R01/02\*1202\*00

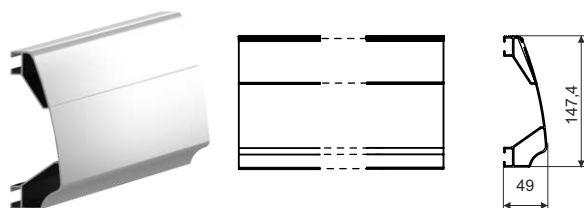

Zábranový profil hliníkový, eloxovaný - H 250mm  
Aluminium bar for side protection, eloxed - H 250mm

Kód/Code	Materiál/Mat.	MJ/UM	Váha Weight
141545	hliník/aluminium	kus/piece	1,980 kg

 VCA Homologácia  
VCA approved  
E11 73R01/02\*1202\*00

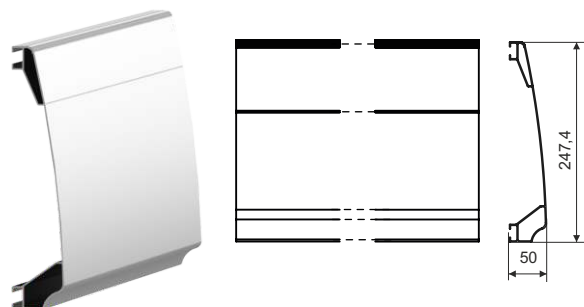

#### 1 VÝŠKA H 150 mm



#### 2 VÝŠKA H 250 mm



#### 3 VÝŠKA H 300 mm (150+150)



#### 4 VÝŠKA H 400 mm (150+250)

141605

HLINÍKOVÁ ZÁBRANA H 150

141670

141620

HLINÍKOVÁ ZÁBRANA H 250

141685

#### 5 VÝŠKA H 400 mm (250+150)

141615

HLINÍKOVÁ ZÁBRANA H 250

141680

141610

HLINÍKOVÁ ZÁBRANA H 150

141675

#### 6 VÝŠKA H 500 mm (250+250)

141615

HLINÍKOVÁ ZÁBRANA H 250

141680

141620

HLINÍKOVÁ ZÁBRANA H 250

141685

#### 7 VÝŠKA H 400 mm (150+100+150)

141630

HLINÍKOVÁ ZÁBRANA H 150

141670

HLINÍKOVÁ ZÁBRANA H 150

141675

#### 8 VÝŠKA H 500 mm (150+200+150)

141640

HLINÍKOVÁ ZÁBRANA H 150

141670

HLINÍKOVÁ ZÁBRANA H 150

141675

VCA Homologácia  
VCA approved  
E11 73R01/02\*1202\*00

**VÝŠKA H 150 mm****1**

Konzoly: 123205 - 123282



141605

HLINÍKOVÁ ZÁBRANA H 150



141670

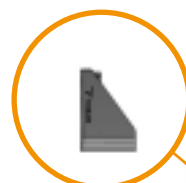

141675

HLINÍKOVÁ ZÁBRANA H 150



141610

VCA Homologácia  
VCA approved  
E11 73R01/02\*1202\*00

**VÝŠKA H 250 mm****2**

Konzoly: 123205 - 123210 - 123282



141615

HLINÍKOVÁ ZÁBRANA H 250



141680

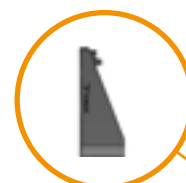

141685

HLINÍKOVÁ ZÁBRANA H 250



141620

VCA Homologácia  
VCA approved  
E11 73R01/02\*1202\*00

**VÝŠKA H 300 mm (150+150)****3**

Konzoly: 123210 - 123282



VCA Homologácia  
VCA approved  
E11 73R01/02\*1202\*00

**VÝŠKA H 400 mm (150+250)****4**

Konzoly: 123220 - 123215  
123282 - 123054



VCA Homologácia  
VCA approved  
E11 73R01/02\*1202\*00

**VÝŠKA H 400 mm (250+150)****5**

Konzoly: 123220 - 123215  
123282 - 123054



VCA Homologácia  
VCA approved  
E11 73R01/02\*1202\*00

**VÝŠKA H 500 mm (250+250)****6**

Konzoly: 123220 - 123215  
123282 - 123054

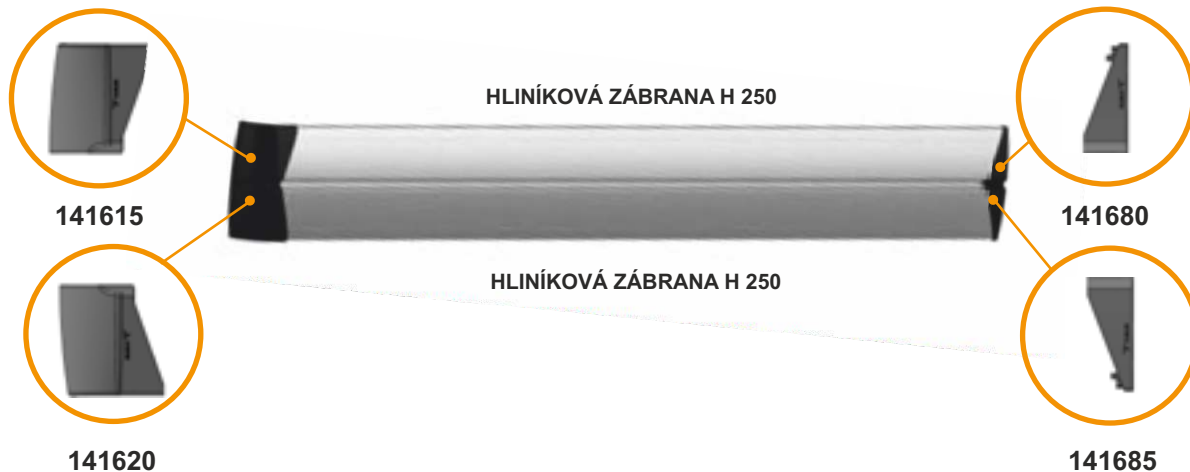

VCA Homologácia  
VCA approved  
E11 73R01/02\*1202\*00

**VÝŠKA H 400 mm (150+100+150)****7**

Konzoly: 123220 - 123215 - 123282  
123210 - 123054

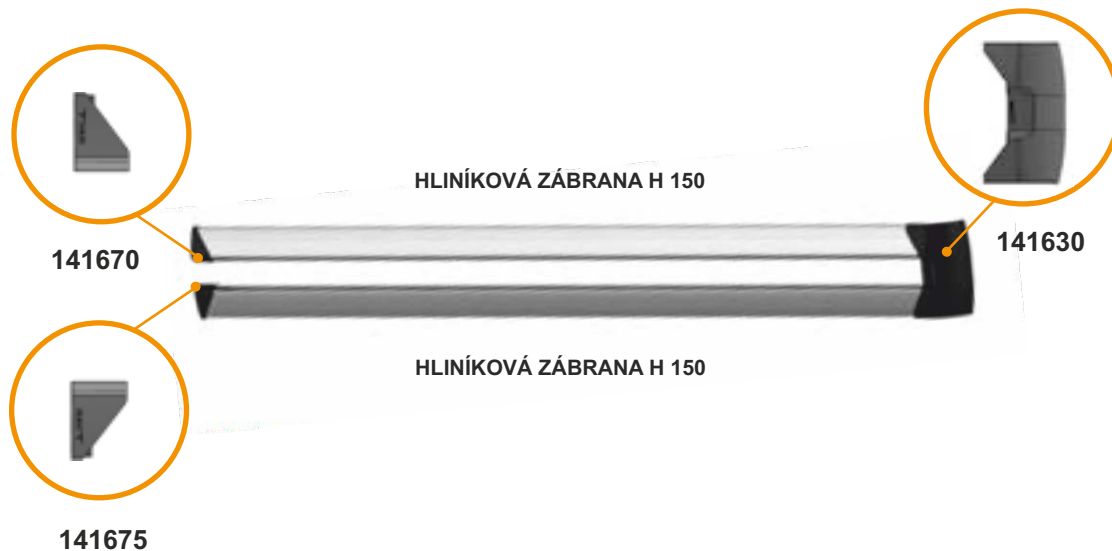
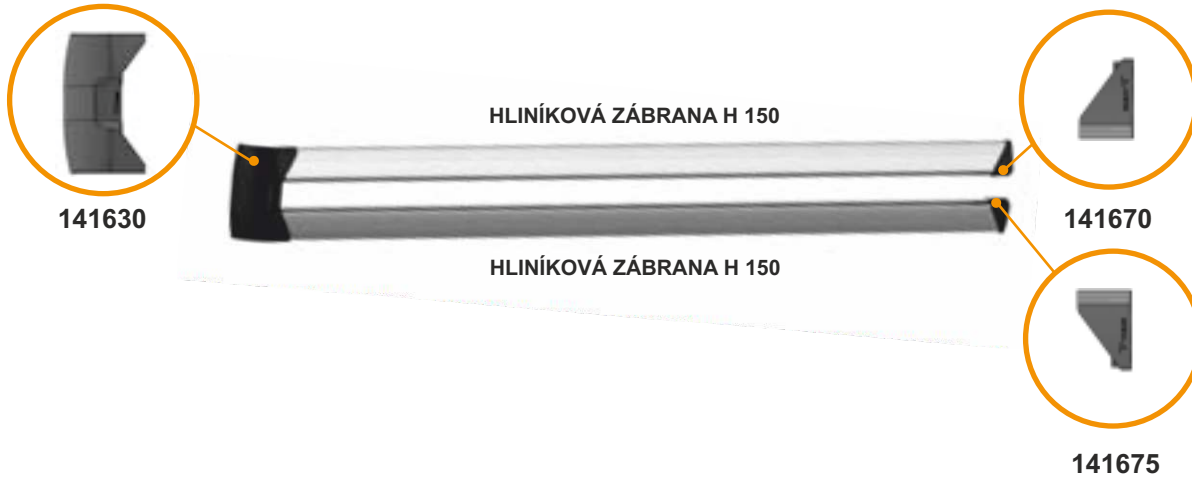

VCA Homologácia  
VCA approved  
E11 73R01/02\*1202\*00

**VÝŠKA H 500 mm (150+200+150) 8**

Konzoly: 123220 - 123215  
123282 - 123054

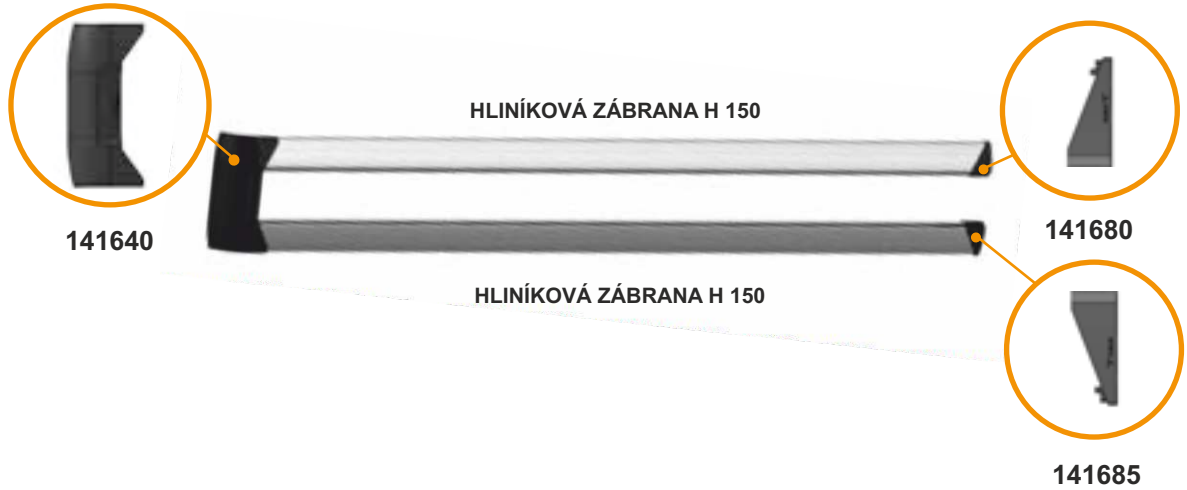

VCA Homologácia  
VCA approved  
E11 73R01/02\*1202\*00

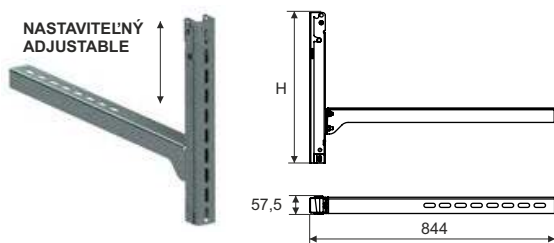
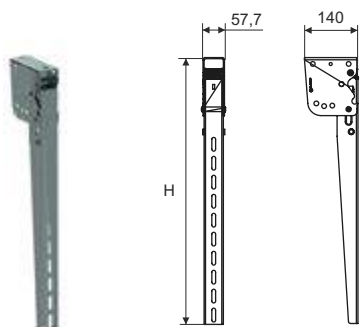
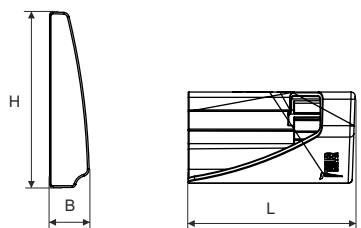
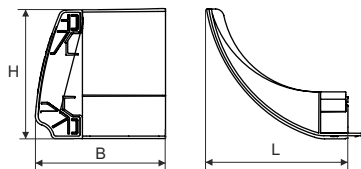
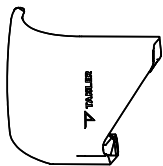

Koncovka oblá veľká do zábranového profilu - čierna  
Big plastic header for side protecting bars - black

Kód/Code	Materiál Material	MJ/UM	Rozmery v mm L x B x H	Váha Weight
141605	plast/plastic	kus/piece	237,9x156,7x155,8	0,200kg
141610	plast/plastic	kus/piece	237,9x156,7x155,8	0,200kg
141615	plast/plastic	kus/piece	237,9x156,7x255,8	0,280kg
141620	plast/plastic	kus/piece	237,9x156,7x255,8	0,280kg
141630	plast/plastic	kus/piece	237,9x156,7x411,7	0,450kg
141640	plast/plastic	kus/piece	237,9x156,7x511,6	0,530kg

Koncovka do zábranového profilu - čierna  
Plastic caps for side protecting bars - black

Kód/Code	Materiál Material	MJ/UM	Rozmery v mm L x B x H	Váha Weight
141670	plast/plastic	kus/piece	102,9x56,7x154,3	0,090kg
141675	plast/plastic	kus/piece	102,9x56,7x154,3	0,090kg
141680	plast/plastic	kus/piece	102,8x56,7x254,3	0,110kg
141685	plast/plastic	kus/piece	102,8x56,7x254,3	0,110kg

Držiak zábrany proti bočnému vklínieniu  
Brackets for side protecting bars

Kód/Code	Povrch. úprava Surface treat.	MJ/UM	H (mm)	Váha Weight
123205	magnelis/magnelis	kus/piece	430	1,970 kg
123210	magnelis/magnelis	kus/piece	572	2,230 kg
123215	magnelis/magnelis	kus/piece	710	2,440 kg
123220	magnelis/magnelis	kus/piece	790	2,550 kg

Držiak zábrany proti bočnému vklínieniu - nastaviteľný  
Bracket for side protecting bars - adjustable

Kód/Code	Povrch. úprava Surface treat.	MJ/UM	H (mm)	Váha Weight
123282	magnelis/magnelis	kus/piece	520	4,120 kg

Spojovací materiál pre zábranový profil 141540 a 141545  
Fixing insert for side protecting bars 141540 and 141545

Kód/Code	Materiál/Material	MJ/UM	Váha Weight
141690	ocel/steel	kus/piece	0,010kg